

# Perfis Esponjosos

Legenda: \* Policloroprene (Neoprene) | \*\* EPDM | \*\*\*Nitrílica

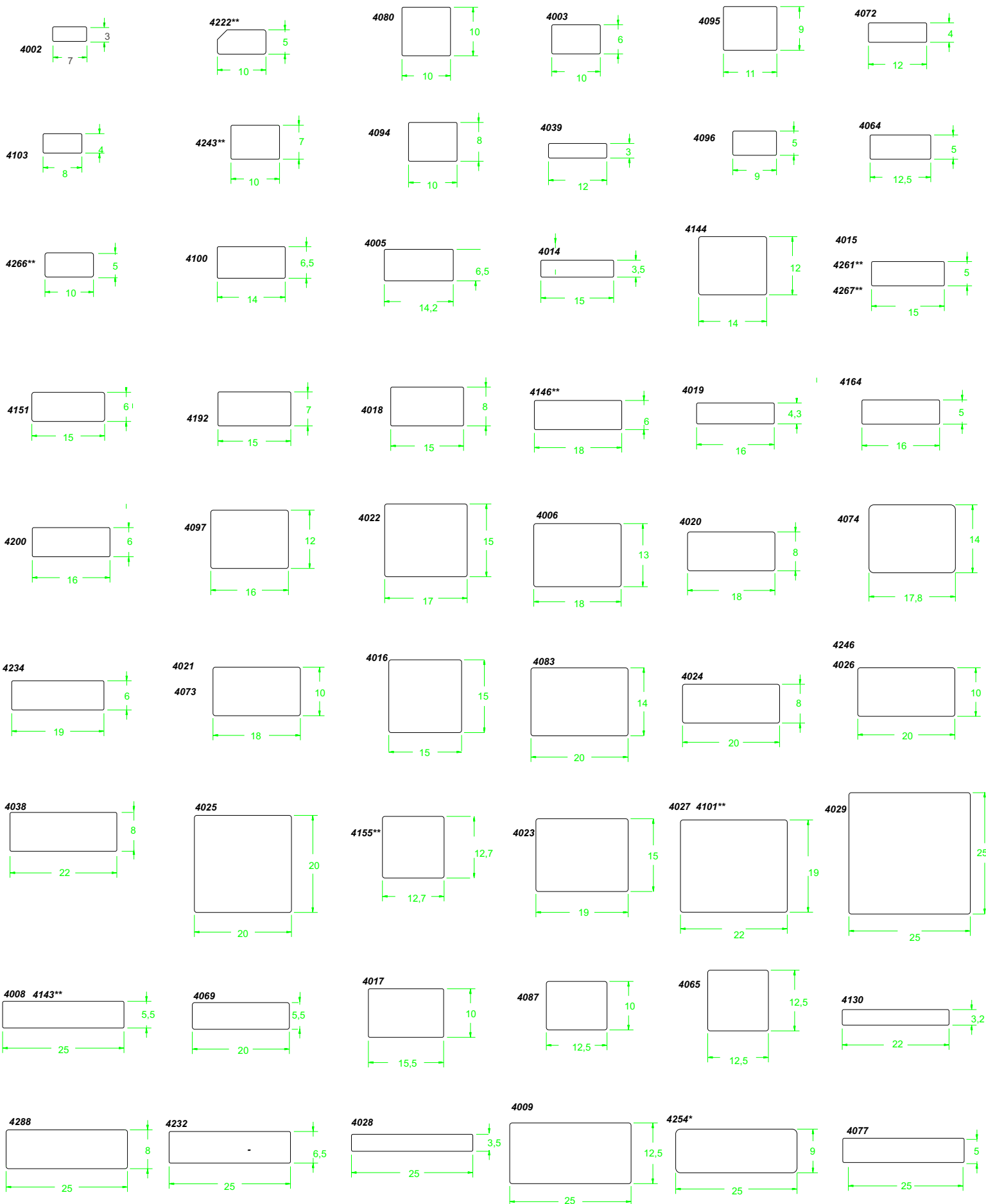

# Perfis Esponjosos

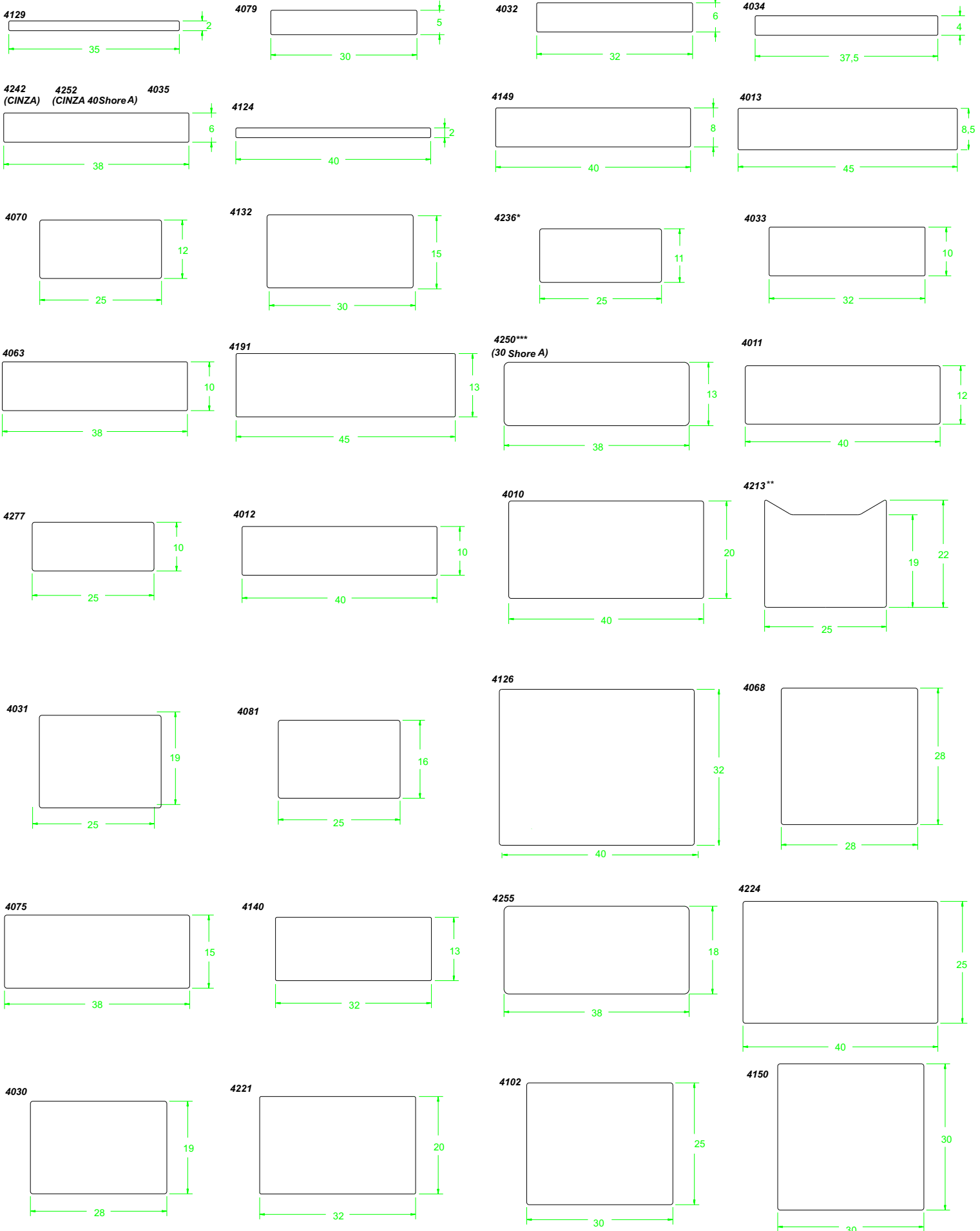

# Perfis Esponjosos

4259



4176

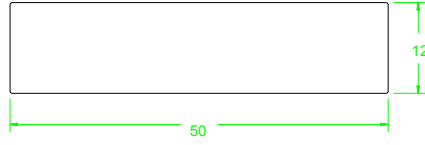

4196

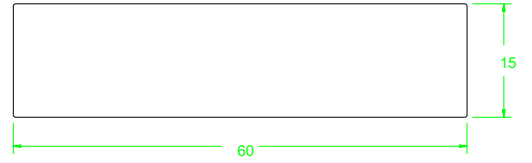

4040

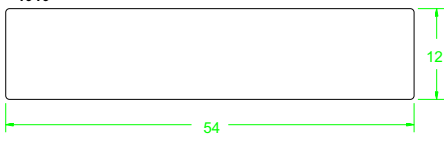

4037 4076\*\*

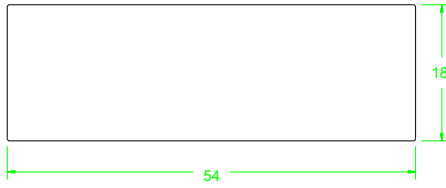

4214

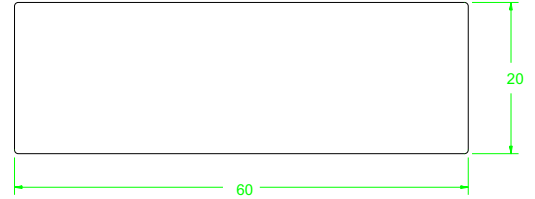

4152

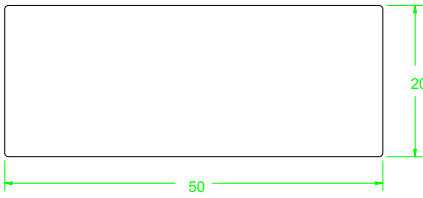

4089 4082\*\*

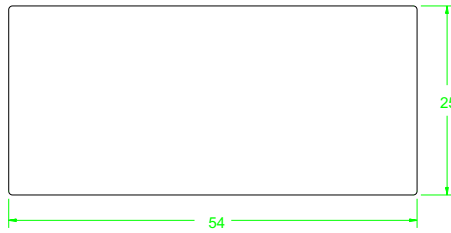

4135 4209  
(15 Shore A)

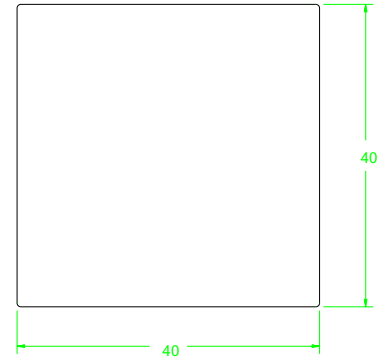

4118

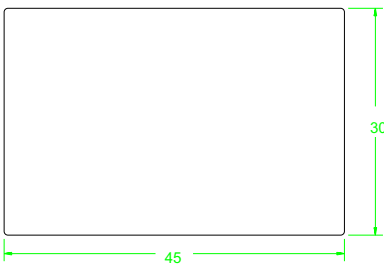

4181

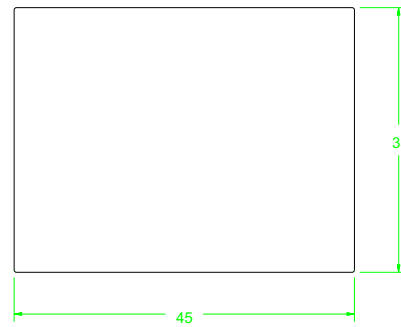

4119  
(15 Shore A)

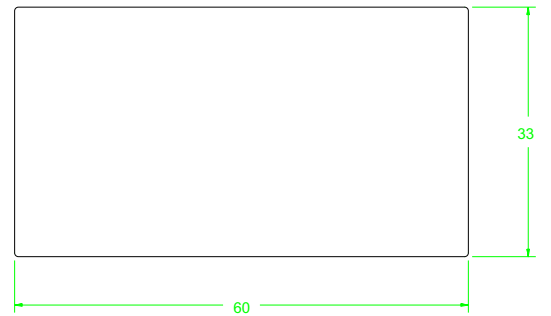

4001

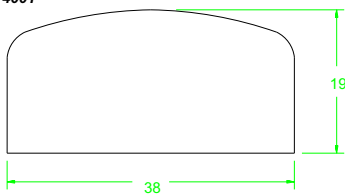

4098

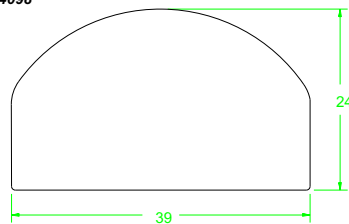

4182

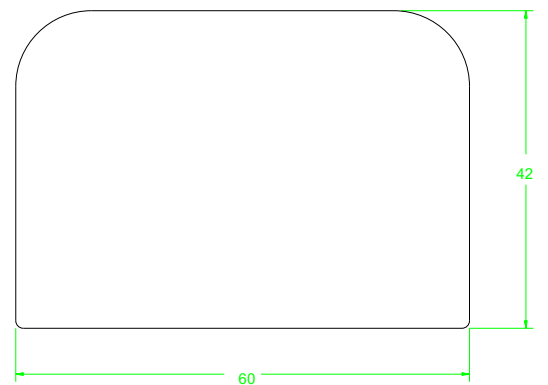

# Perfis Esponjosos

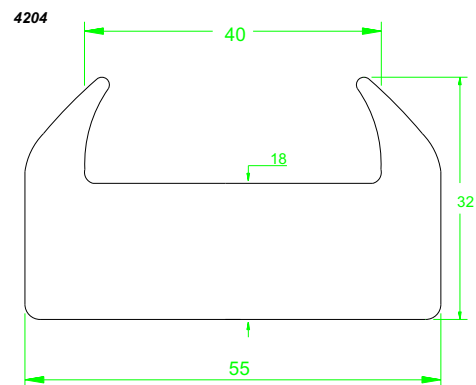
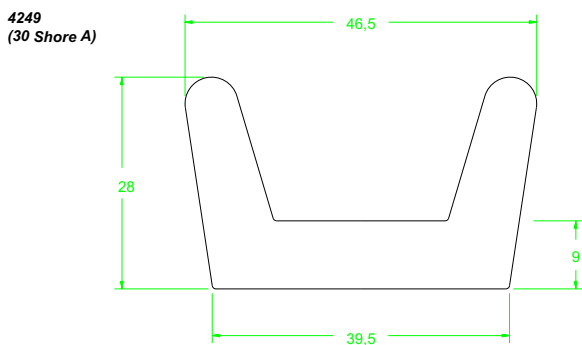
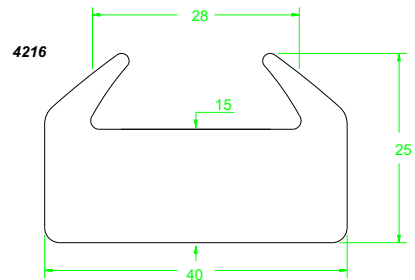
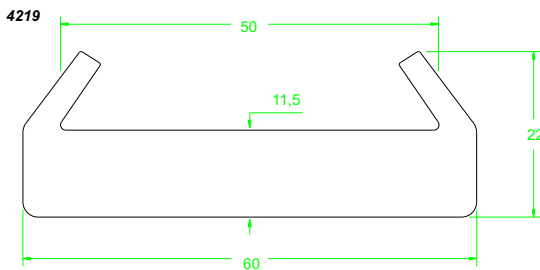
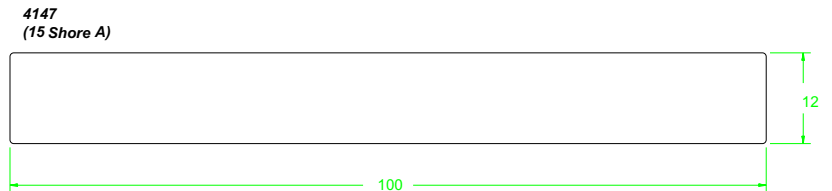
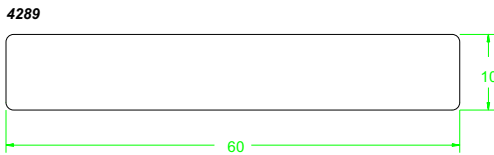
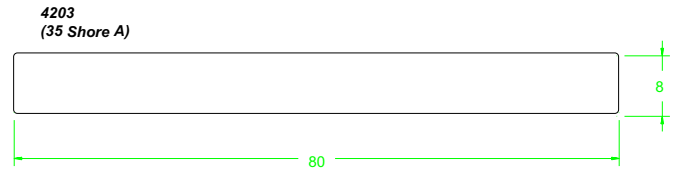
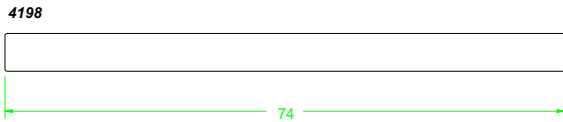
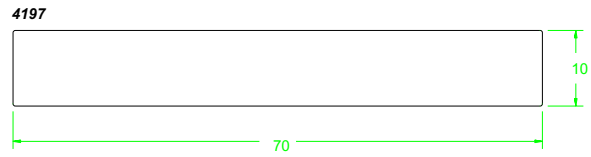
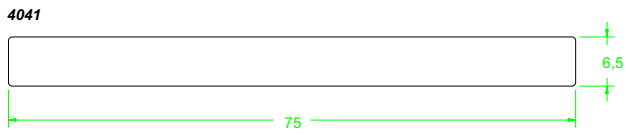
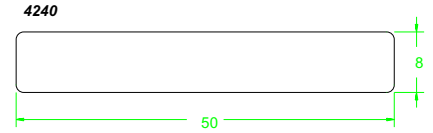
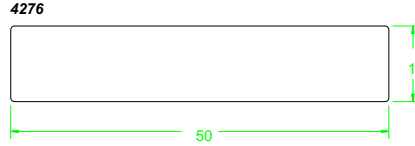
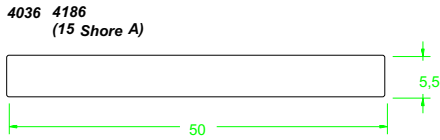
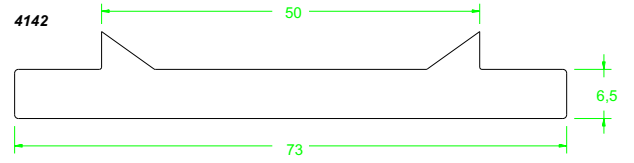
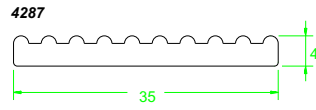
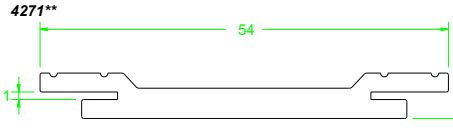

# Perfis Esponjosos

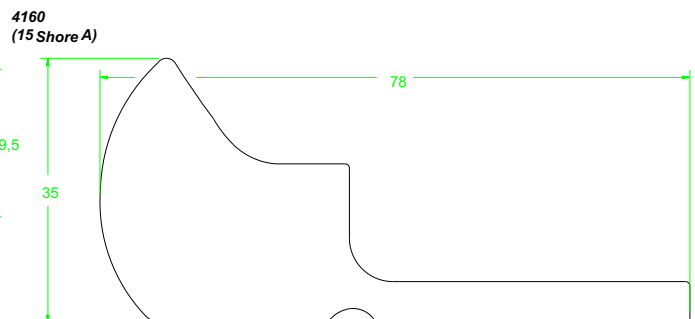
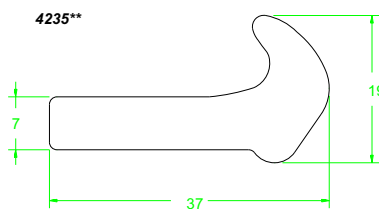
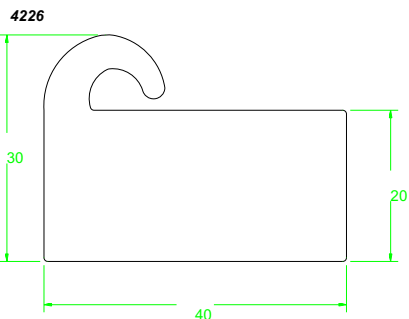
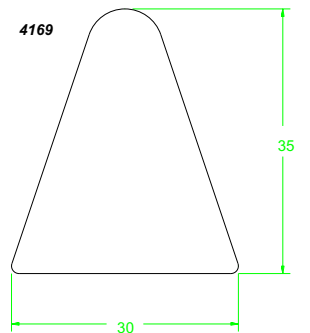
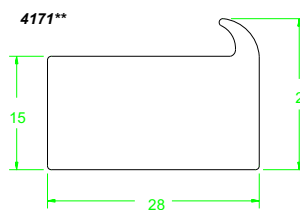
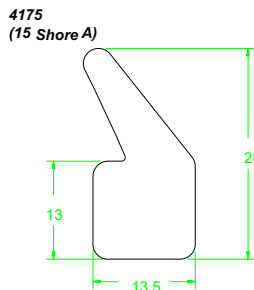
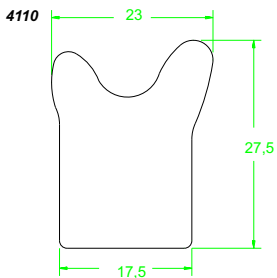
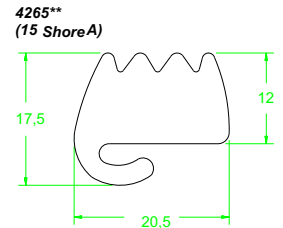
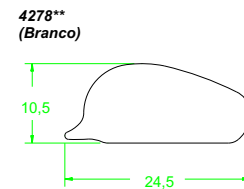
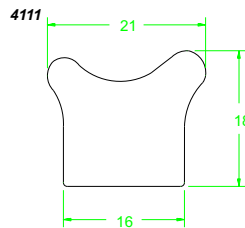
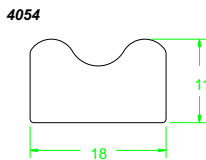
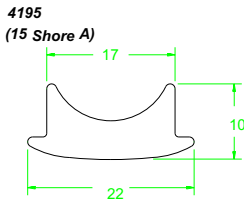
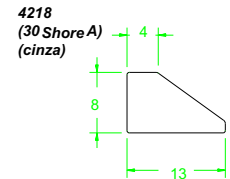
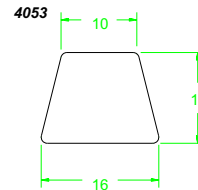
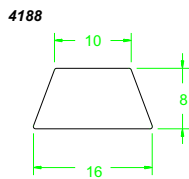
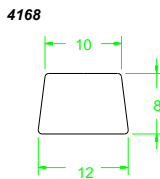
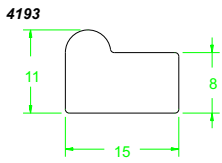
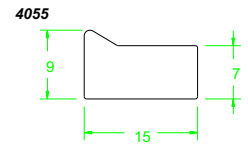
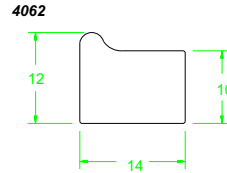
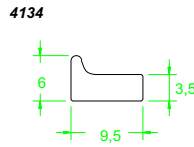
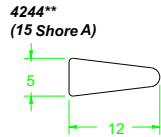
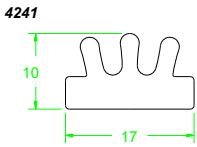
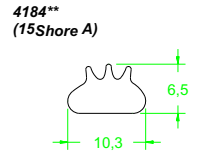
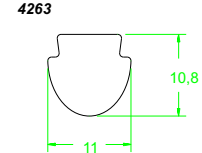
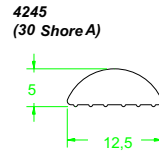
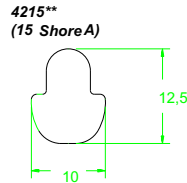
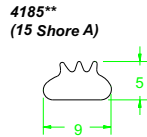
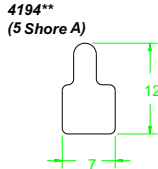
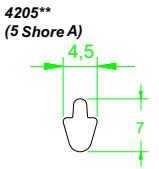
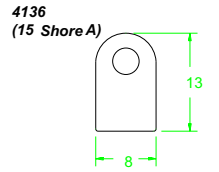
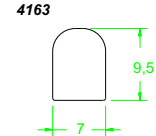
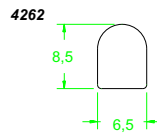
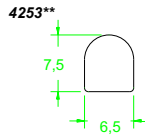
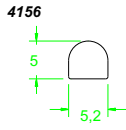
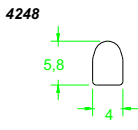
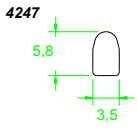

# Perfis Esponjosos

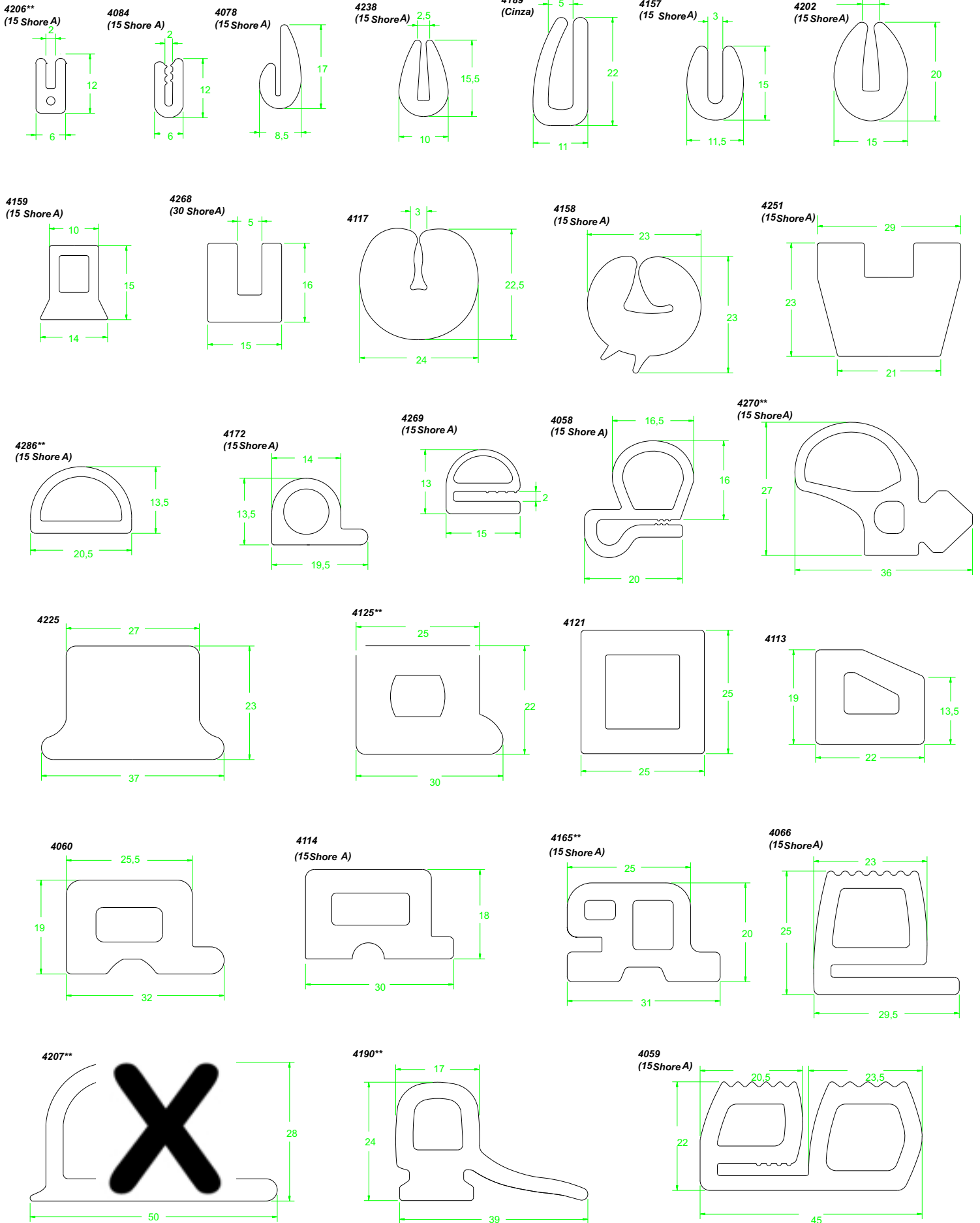

# Perfis Esponjosos

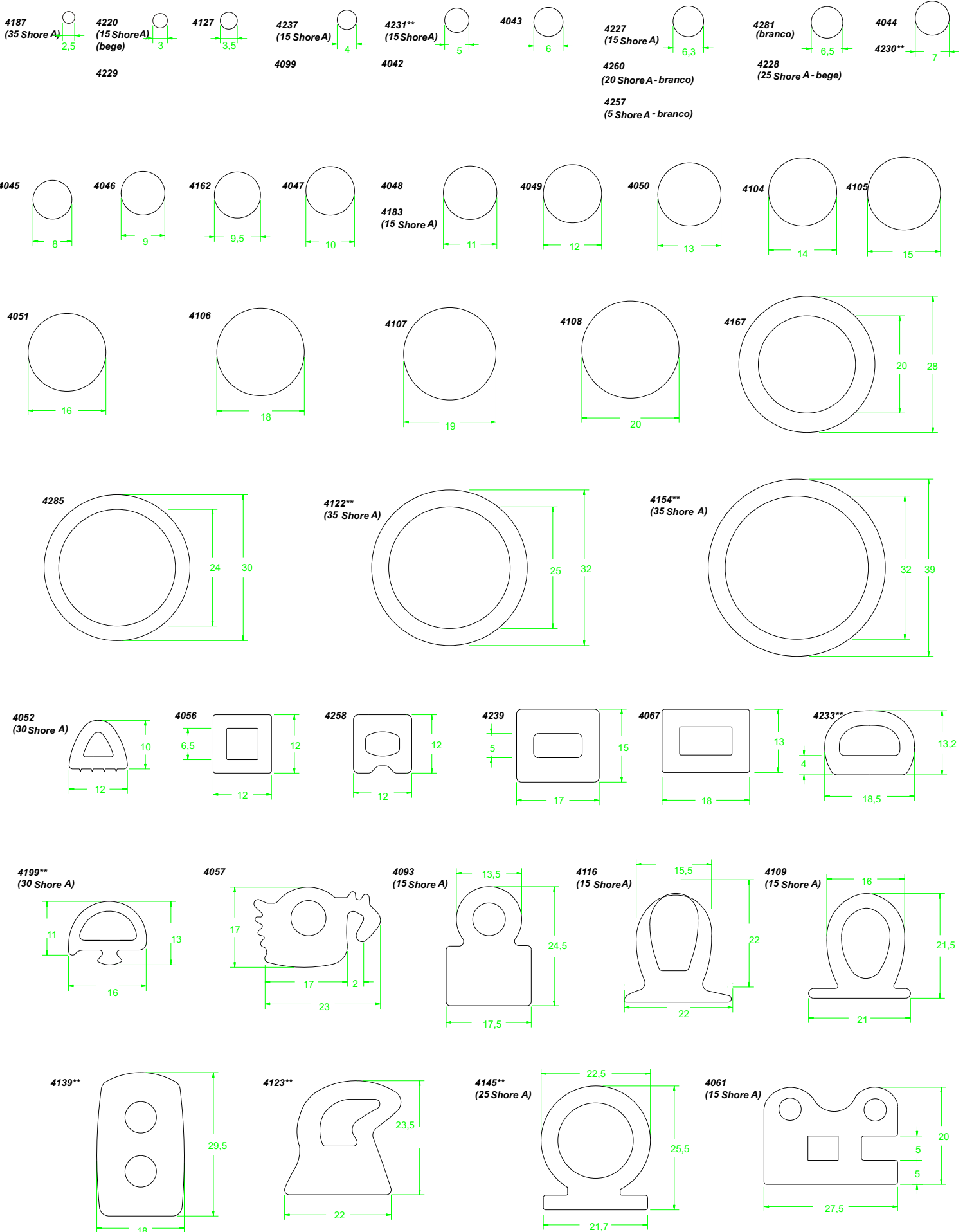

# Perfis Esponjosos

